

MATLAB EXPO

클라우드 기반의 MATLAB 영상 검사 시스템 개발

성호현 부장, 매스웍스코리아



What is Automated Visual Inspection?

Automated visual inspection is the evaluation of images or video, typically to detect failures and quality defects—often in manufacturing processes.

Automated Defect Detection

Machine Vision

Optical Inspection

Automated Inspection

MATLAB AI in a Cloud-based Visual Inspection System

Requirements: A visual inspection system should:

- Be secure
- Run at-scale
- Be re-purposable for different applications

MATLAB's AI solution was operationalized on the cloud using:

- Microservices built to modern standards and best practices for scalability / security
- DevOps processes for agility in development and deployment of AI and vision algorithms

Sample Problem: Detecting and characterizing defects on a Raspberry Pi

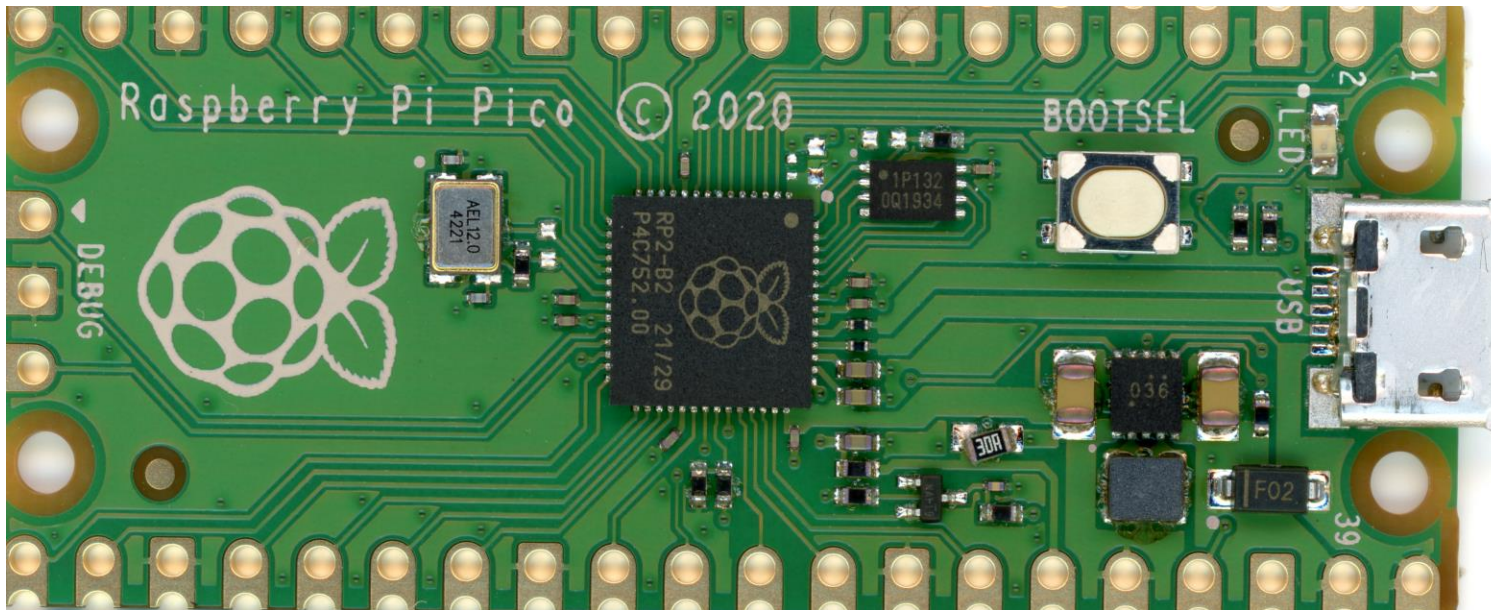

Potential defects include:

- Misaligned components
- Bad assembly
- Damage
- Missing Solder
- Labeling mistakes
- Other?

Demonstration

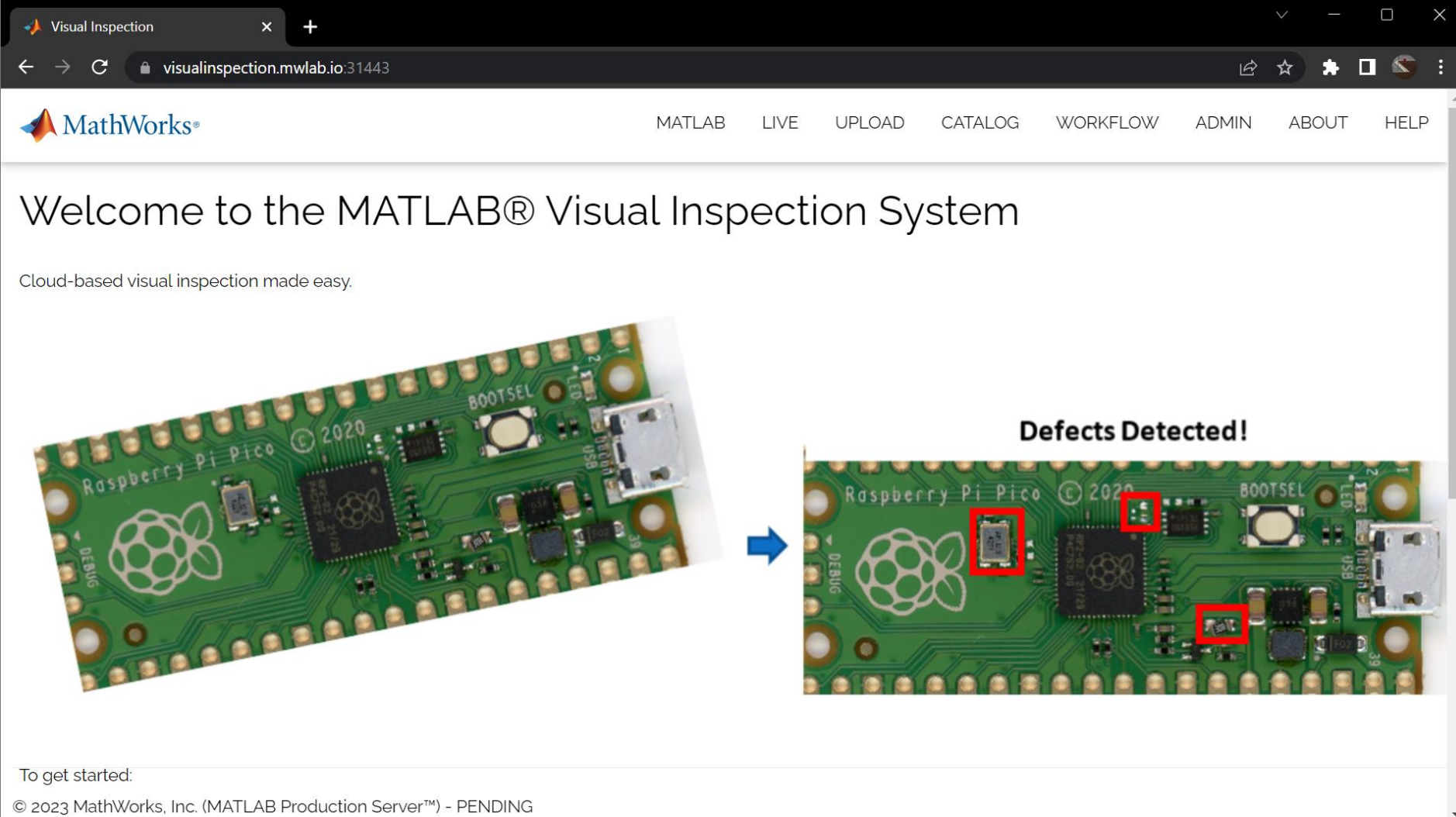

The screenshot displays a web browser window with the URL `visualinspection.mwlab.io:31443`. The page features the MathWorks logo and a navigation menu with links for MATLAB, LIVE, UPLOAD, CATALOG, WORKFLOW, ADMIN, ABOUT, and HELP. The main heading reads "Welcome to the MATLAB® Visual Inspection System" with the subtext "Cloud-based visual inspection made easy." Below this, two images of a Raspberry Pi Pico board are shown. The left image is the original board, and the right image, titled "Defects Detected!", shows the same board with three red boxes highlighting specific components: a small square component on the left, a component near the center, and a component on the right. A blue arrow points from the original board to the detected board.

Visual Inspection

visualinspection.mwlab.io:31443

MathWorks®

MATLAB LIVE UPLOAD CATALOG WORKFLOW ADMIN ABOUT HELP

Welcome to the MATLAB® Visual Inspection System

Cloud-based visual inspection made easy.

Defects Detected!

To get started:





© 2023 MathWorks, Inc. (MATLAB Production Server™) - PENDING

A Cloud-based MATLAB Visual Inspection System

System Architecture and Overview

End Users 

Access from any Mobile Device with any standards-compliant browser

Video / Stream    Images 

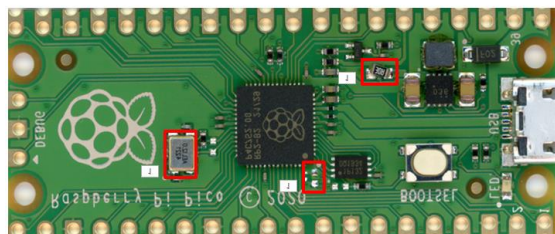

DevOps for Cloud Infrastructure

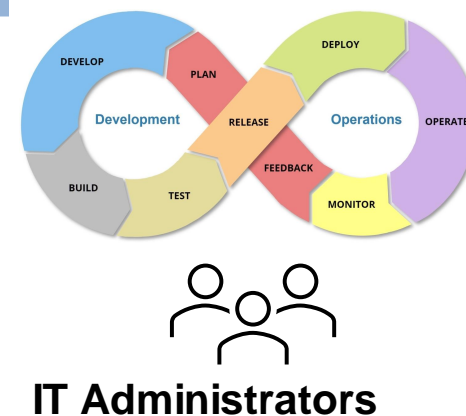
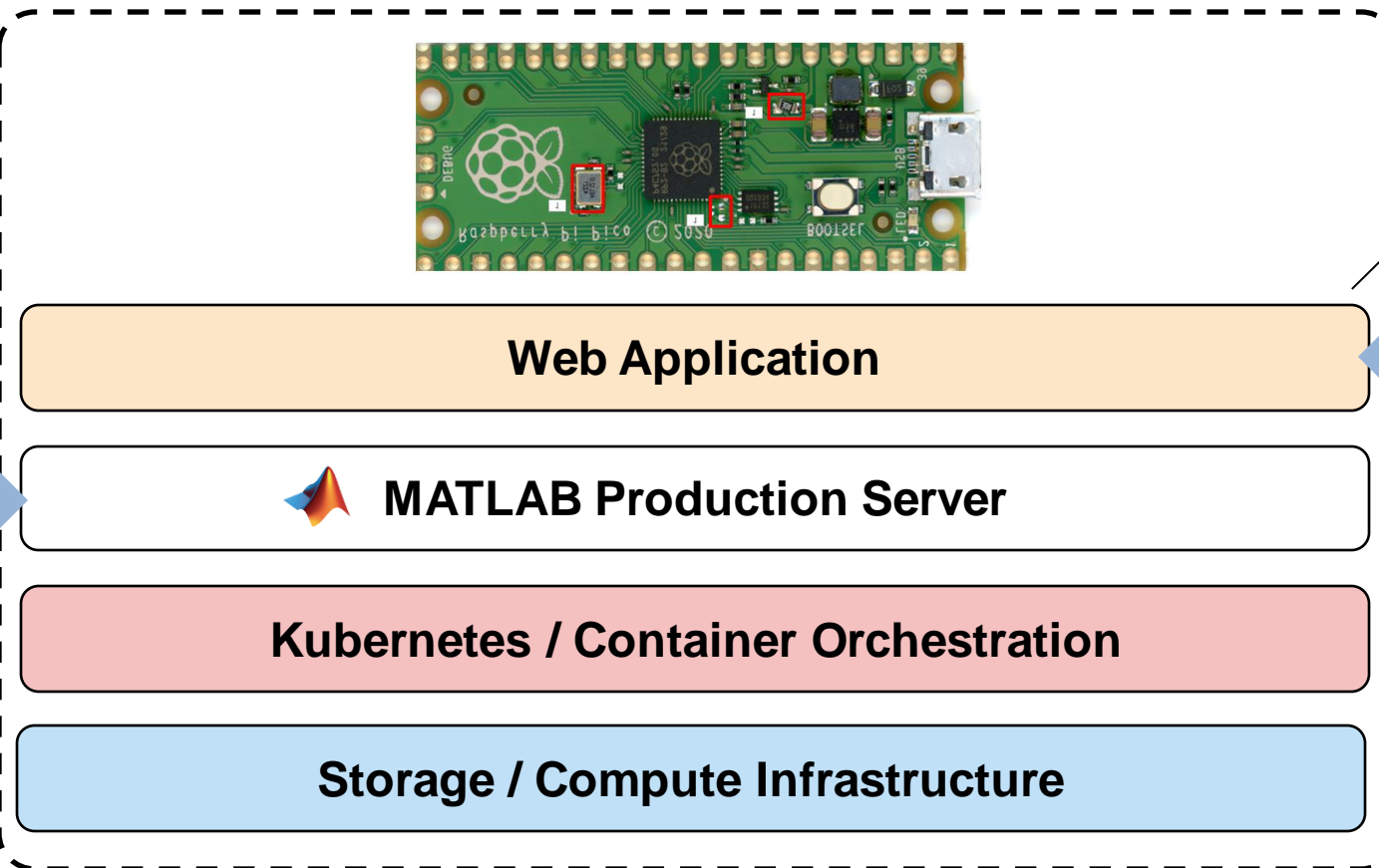
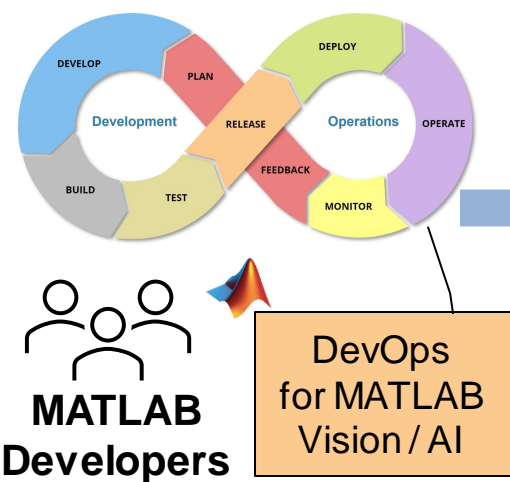

MATLAB Algorithm Development

Image Processing Toolbox

Computer Vision Toolbox

Deep Learning Toolbox

Statistics and Machine Learning Toolbox

...

MATLAB Algorithm Development

Contribute | Manage Add-Ons

◀
🏠

Search for add-ons

🔍

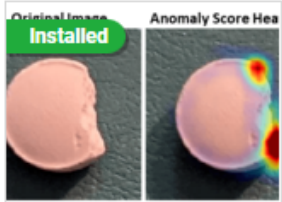

Computer Vision Toolbox Automated Visual Inspection Library
by MathWorks Computer Vision Toolbox Team STAFF

Identify anomalies or defects in images to assist and improve quality assurance processes.

▶ MathWorks Optional Feature

★★★★★ (0)

67 Downloads ⓘ

Updated 15 Mar 2023

Manage

Overview
Reviews (0)
Discussions (0)

The Computer Vision Toolbox™ Automated Visual Inspection Library offers functions that enable you to train, calibrate, and evaluate anomaly detection networks.

The library enables:

Training and evaluating state of the art anomaly detectors including [PatchCore](#), [FCDD](#), and [FastFlow](#). All detectors support standalone deployment with MATLAB Coder, GPU Coder, and MATLAB Compiler.



Calibrating trained networks by setting the anomaly thresholds for many number of false positive and negative that can

Requires

- ✔ Computer Vision Toolbox
- ✔ Image Processing Toolbox

MATLAB Release Compatibility

Created with R2022b
Compatible with R2022b to R2023a

Platform Compatibility

Windows macOS Linux

Tags Add Tags

computer vision
deep learning
image processing

MATLAB Algorithm Development

Documentation Examples Functions Blocks Apps

Automated Visual Inspection

R2023a

Automate quality assurance tasks using anomaly detection and classification techniques

Automated visual inspection (AVI) is a set of techniques used to determine whether an image represents a normal ("good") state or an anomalous ("defective") state. AVI assists and improves quality assurance processes commonly found in manufacturing settings. Modern visual inspection uses machine learning and deep learning techniques to produce useful results.

The specific technique you select to automate a visual inspection task depends on several factors. These factors include the amount of training data available for normal and anomalous samples, the number of anomaly classes to recognize, and the type of localization information required for understanding and monitoring predictions.

To perform automated visual inspection, download the Computer Vision Toolbox™ Automated **Visual Inspection Library** from the Add-On Explorer. For more information on downloading add-ons, see [Get and Manage Add-Ons](#). Some functionality also requires Deep Learning Toolbox™.

Functions

expand all

> Load Training Data

> Train Anomaly Detector

> Detect Anomalies Using Deep Learning

> Visualize and Evaluate Results

Topics

[Getting Started with Anomaly Detection Using Deep Learning](#)

Anomaly detection using deep learning is an increasingly popular approach to automating visual inspection tasks.

Featured Examples

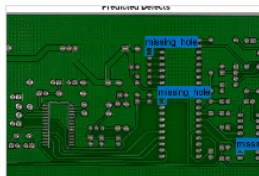

Detect Defects on Printed Circuit Boards Using YOLO v4 Network

Detect, localize, and classify defects in printed circuit boards (PCBs) using a you only look once version 4 (YOLO v4) deep learning network.

[Open Live Script](#)

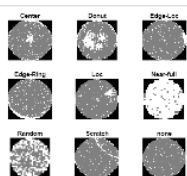

Classify Defects on Wafer Maps Using Deep Learning

Classify manufacturing defects on wafer maps using a simple convolutional neural network (CNN).

[Open Live Script](#)

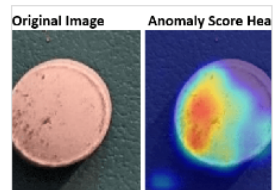

Detect Image Anomalies Using Explainable FCDD Network

Use an anomaly detector to distinguish between normal pills and pills with anomalous chips or contamination.

[Open Live Script](#)

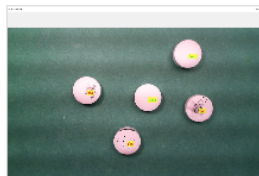

Detect Anomalies in Pills During Live Image Acquisition

Detect anomalies in pills during live image acquisition.

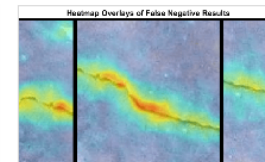

Detect Image Anomalies Using Pretrained ResNet-18 Feature Embeddings

Train a similarity-based anomaly detector using one-class learning of feature embeddings extracted from a pretrained ResNet-18

[Open Live Script](#)

MATLAB Algorithm Development

Documentation Examples **Functions** Blocks Apps

Automated Visual Inspection — Functions

Load Training Data

<code>groundTruth</code>	Ground truth label data
<code>sceneLabelTrainingData</code>	Create training data for scene classification from ground truth
<code>splitAnomalyData</code>	Split data into training, validation and testing sets for anomaly detection

Train Anomaly Detector

<code>trainFCDDAnomalyDetector</code>	Train fully convolutional data description (FCDD) anomaly detection network
<code>trainFastFlowAnomalyDetector</code>	Train FastFlow anomaly detection network
<code>trainPatchCoreAnomalyDetector</code>	Train PatchCore anomaly detection network
<code>anomalyThreshold</code>	Optimal anomaly threshold for set of anomaly scores and corresponding labels

Detect Anomalies Using Deep Learning

<code>fcddAnomalyDetector</code>	Detect anomalies using fully convolutional data description (FCDD) network for anomaly detection
<code>fastFlowAnomalyDetector</code>	Detect anomalies using FastFlow network
<code>patchCoreAnomalyDetector</code>	Detect anomalies using PatchCore network
<code>classify</code>	Classify image as normal or anomalous
<code>predict</code>	Predict unnormalized anomaly scores

Visualize and Evaluate Results

<code>anomalyMap</code>	Predict per-pixel anomaly score map
<code>anomalyMapOverlay</code>	Overlay heatmap on image using per-pixel anomaly scores
<code>viewAnomalyDetectionResults</code>	View anomaly detection results
<code>evaluateAnomalyDetection</code>	Evaluate anomaly detection results against ground truth
<code>anomalyDetectionMetrics</code>	Anomaly detection metrics

Sample Problem: Detecting Defects on a Raspberry Pi

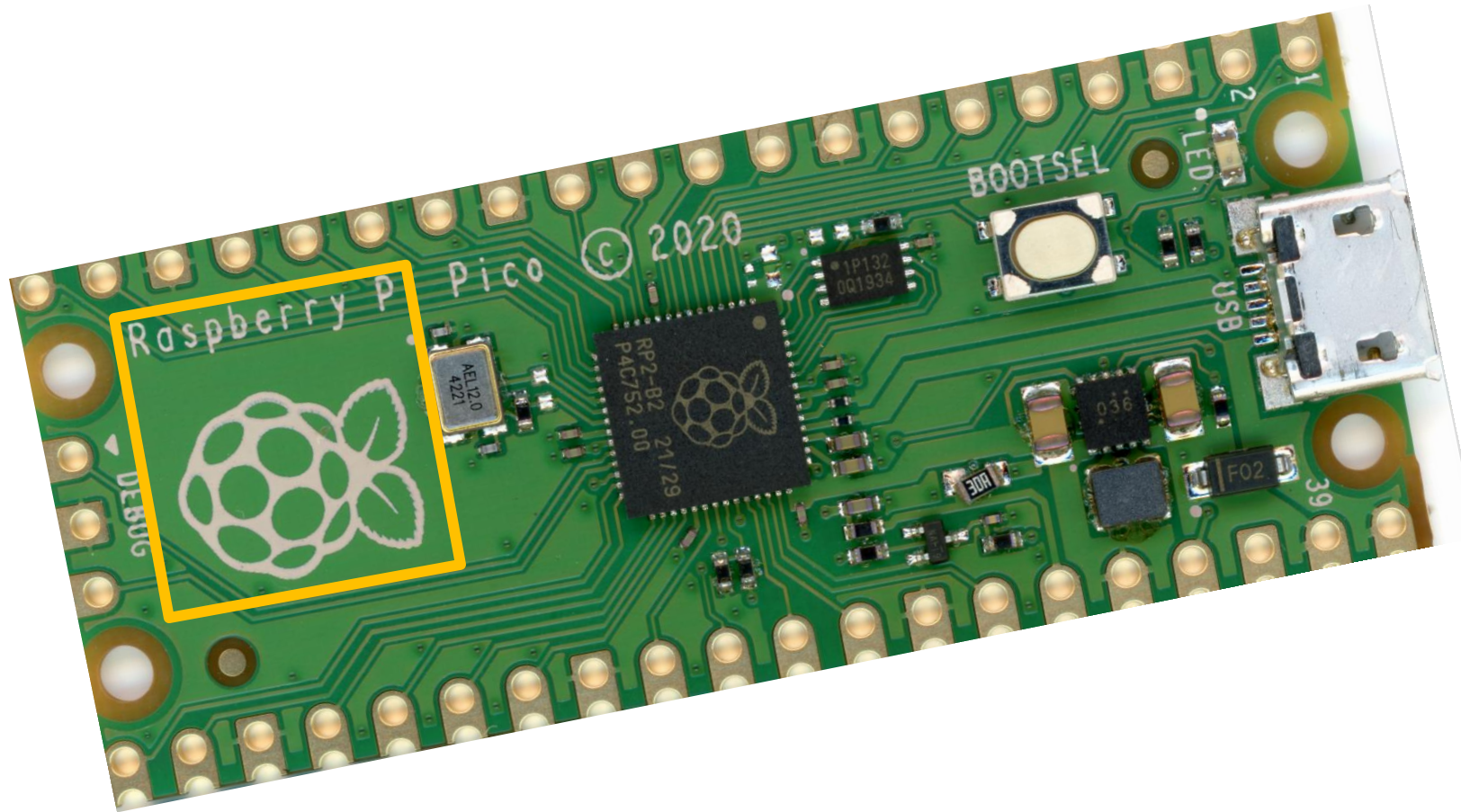

Template-based orientation and preprocessing...

Sample Problem: Detecting Defects on a Raspberry Pi

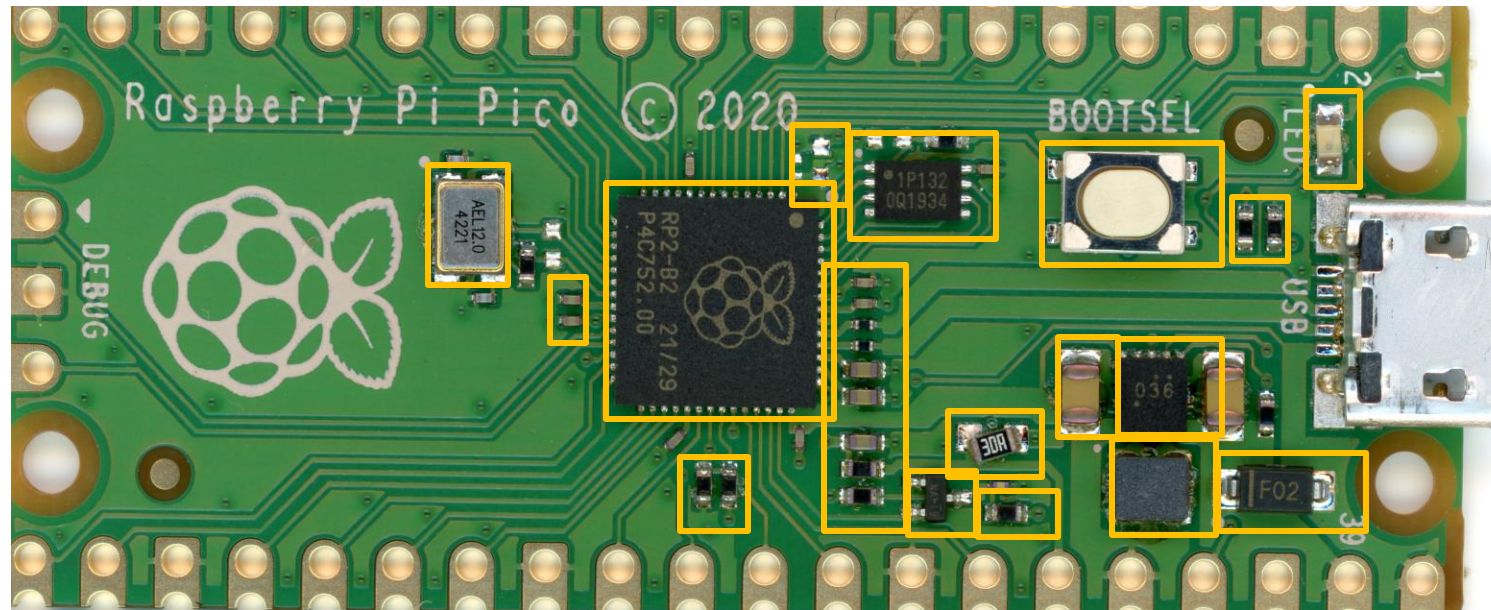

Component detection...

Sample Problem: Detecting Defects on a Raspberry Pi

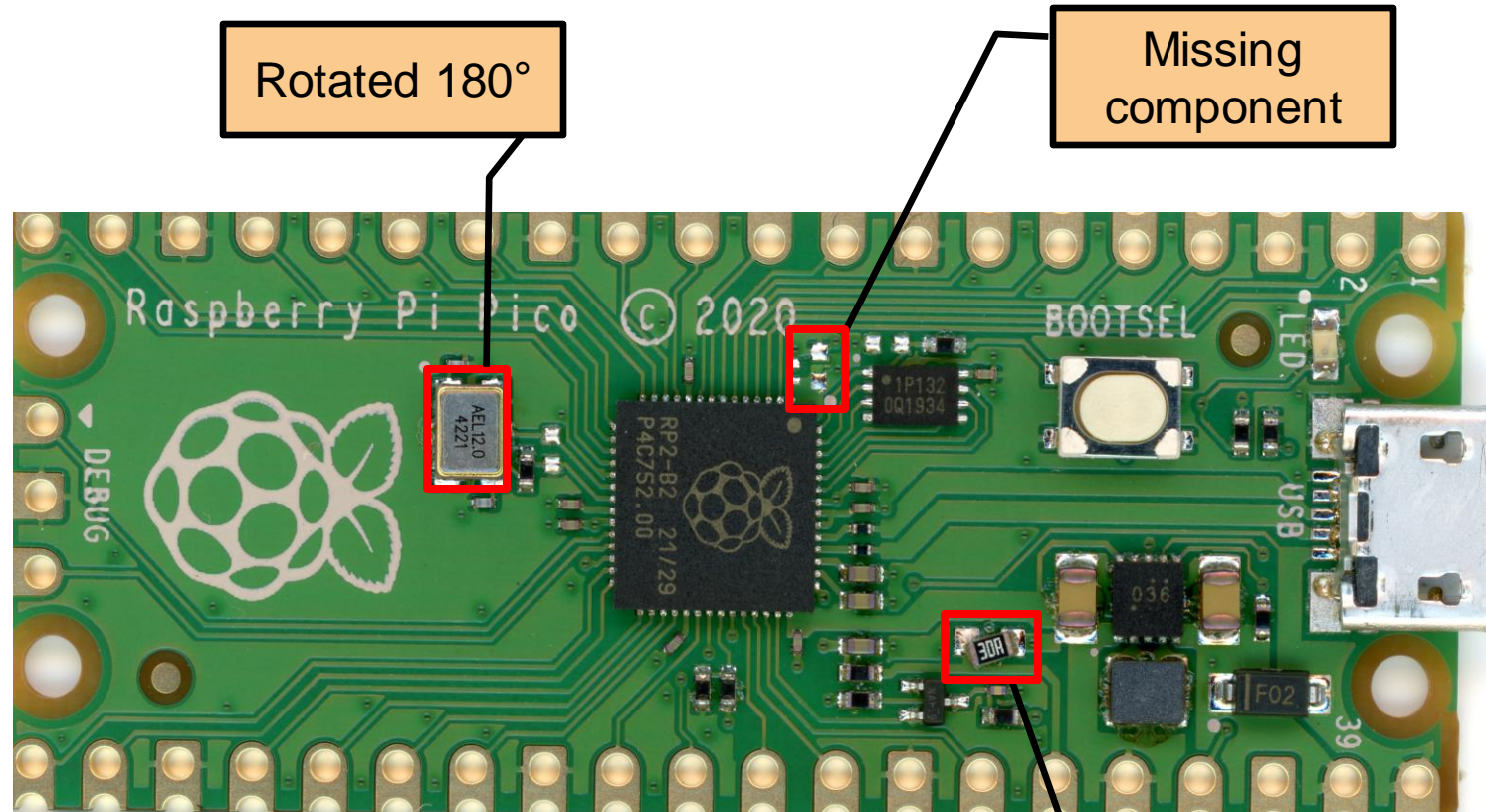

Defect detection and classification...

- QR-Code Triggering
- Live, Constrained Capture (iPhone, iPad, Android)
- Automatic updating of ground truth and model
- Scalable, Cloud-Based Analysis and Reporting



System Architecture

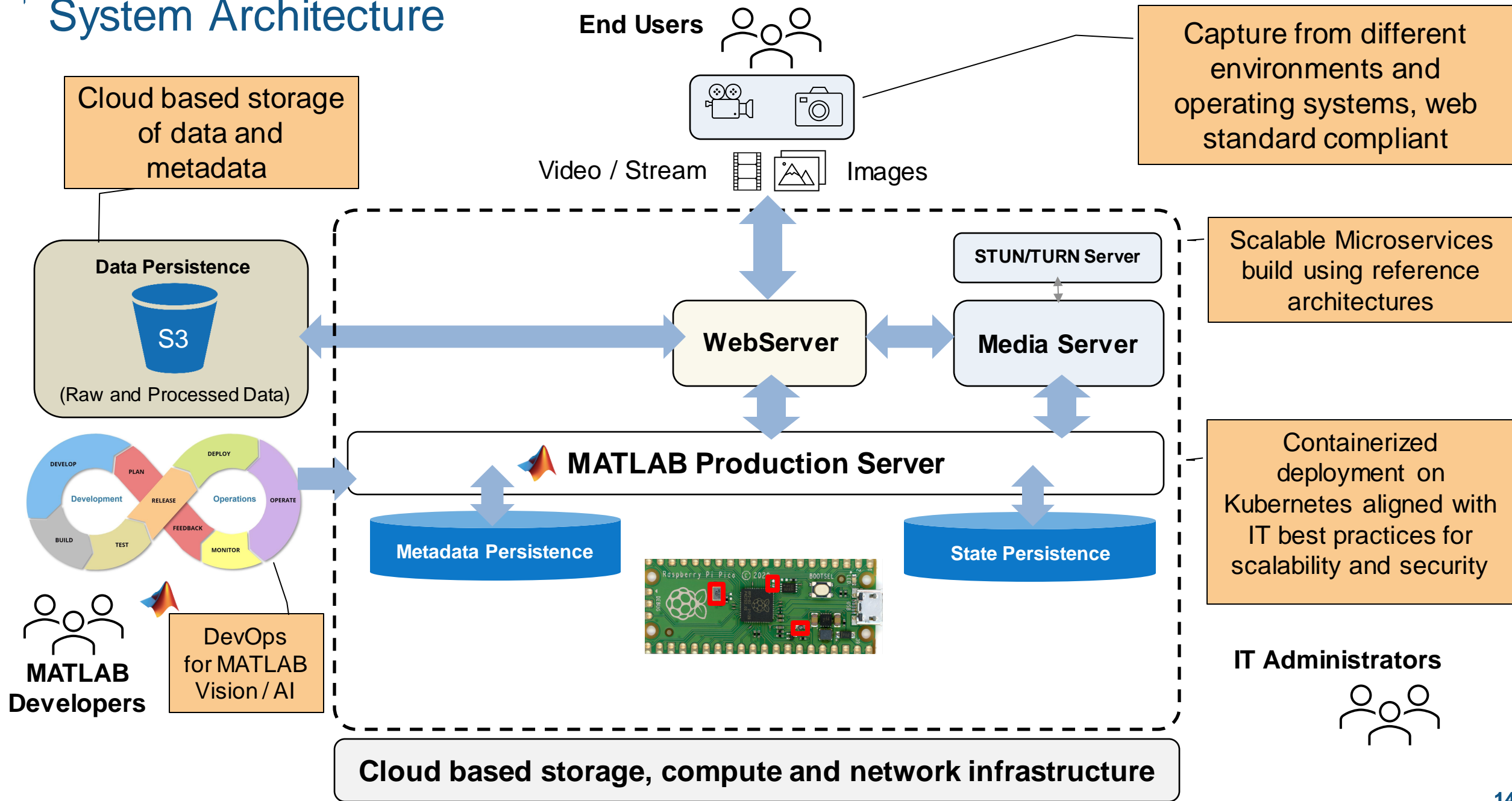

MATLAB from Prototype to Production

- Modern DevOps based automated continuous deployment of MATLAB applications

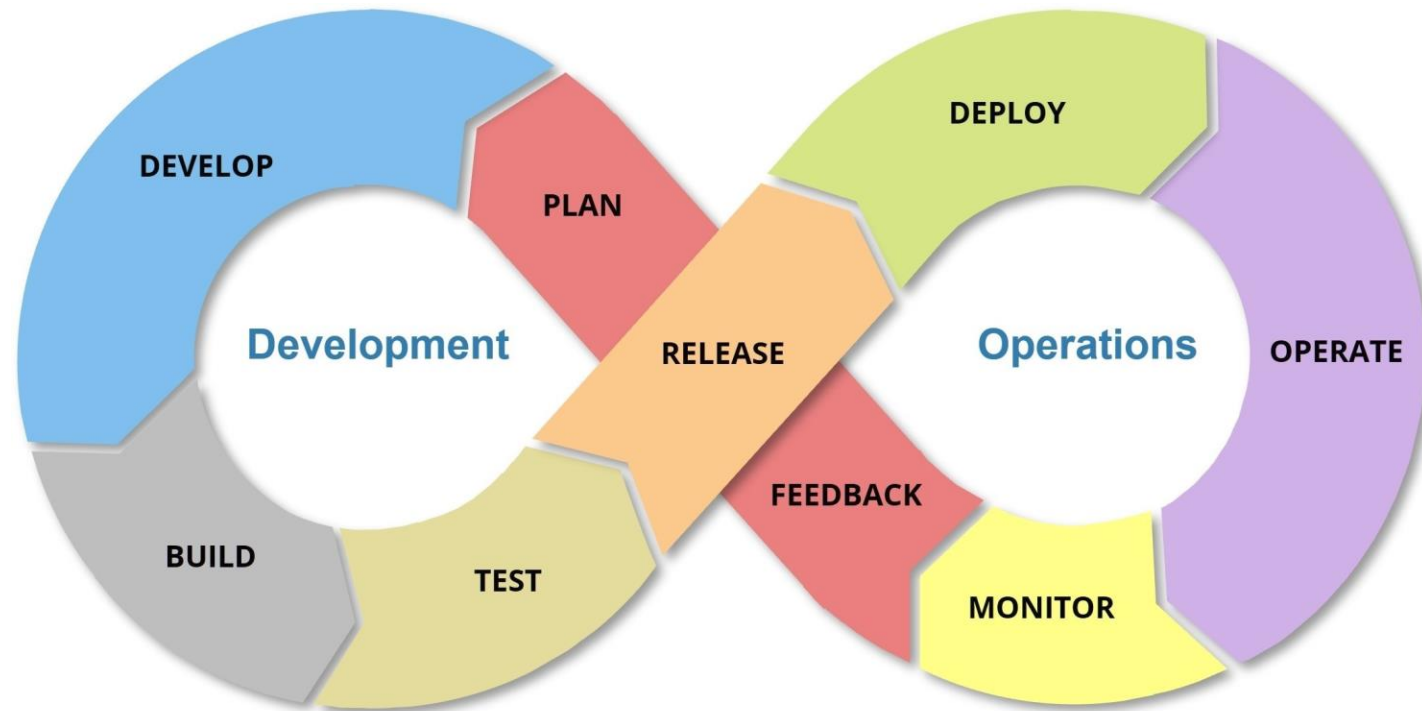

MATLAB Deployment and Scaling

The screenshot displays the OpenShift Cluster Dashboard for a cluster named 'visual-inspection'. The dashboard provides a comprehensive overview of the cluster's health and resource utilization.

Cluster Overview:
 Provider: RKE1 | Kubernetes Version: v1.24.10 | Created: 3.2 days ago | [Install Monitoring](#)

Summary Metrics:
 202 Total Resources | 3 Nodes | 25 Deployments

Capacity Utilization:

- Pods:** Used 61 / 220 (27.73%)
- Cores:** Reserved 5.76 / 16 (36.00%) | Used 0.44 / 16 (2.75%)
- Memory:** Reserved 2.43 / 31 GiB | Used 5.92 / 31 GiB

Component Status:
 Etcd ✓ | Scheduler ✓ | Controller Manager ✓

Deployment Scaling:
 The right side of the dashboard shows a list of deployments. One deployment is highlighted, showing it is in a 'Running' state with 1 instance. The scaling controls allow adjusting the number of instances (currently 1) and the deployment's age (3.1 days).

Take-aways and Conclusion

- MathWorks products along with published reference architectures can be leveraged to build production-grade visual inspection systems for the cloud
- Secure, scalable and agile solutions for AI/Visual Inspection can be built to IT DevOps best practices
- Domain specific toolboxes and support packages are available for MATLAB users to go from prototype to production quickly

Q & A

MATLAB EXPO

Thank you



© 2023 The MathWorks, Inc. MATLAB and Simulink are registered trademarks of The MathWorks, Inc. See [mathworks.com/trademarks](https://www.mathworks.com/trademarks) for a list of additional trademarks. Other product or brand names may be trademarks or registered trademarks of their respective holders.